

	1	2	3	4	5	6	7	8	9
A	Change Log								
B									
C									
D									
E									
F									

Corona Manufacturing 1502 Embler Drive Pflugerville, TX 78660	
TITLE: digital	
Document Number:	REU: C
Date: 10/28/2009 9:36:09 PM	Sheet: 1/9

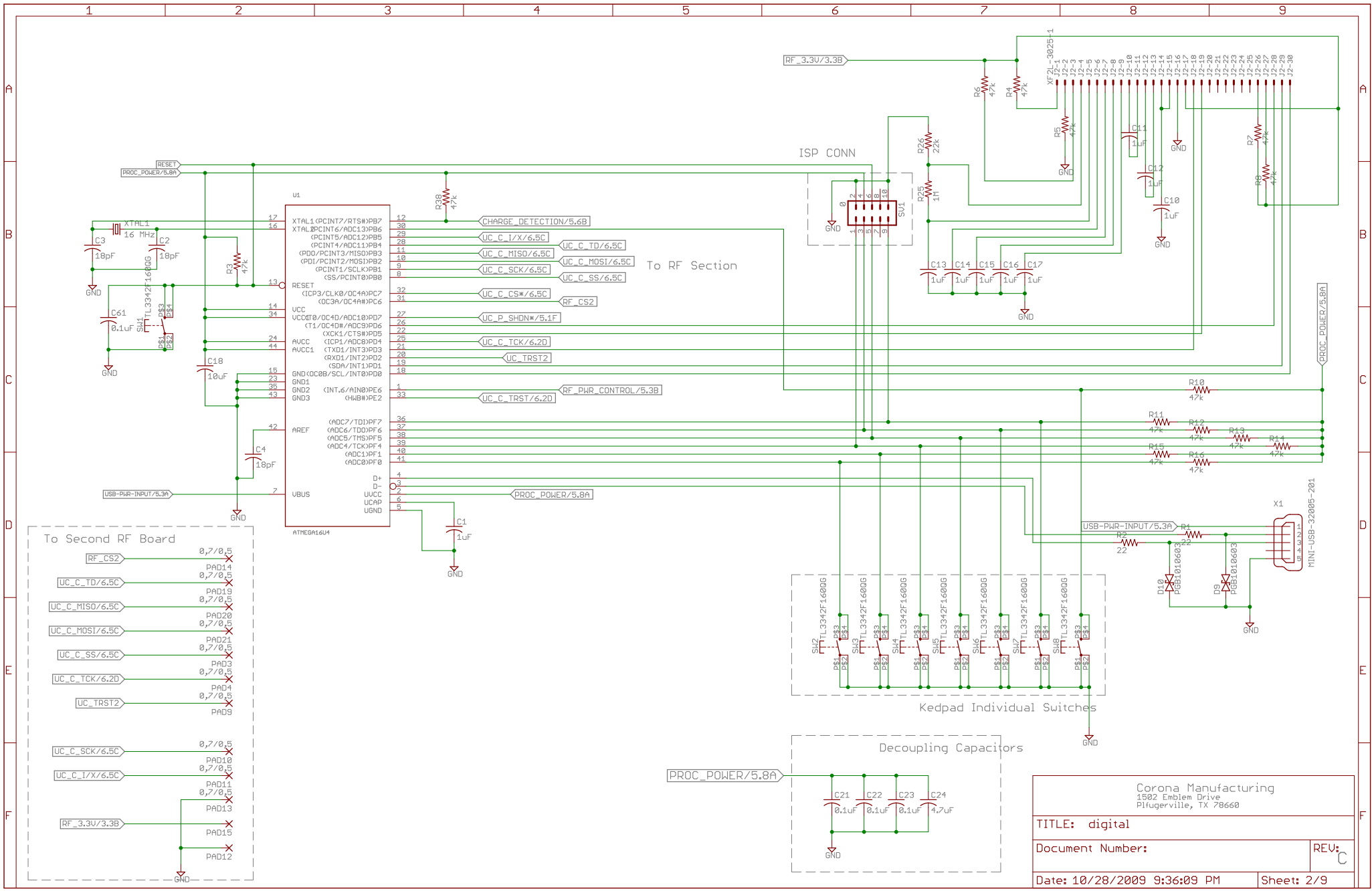

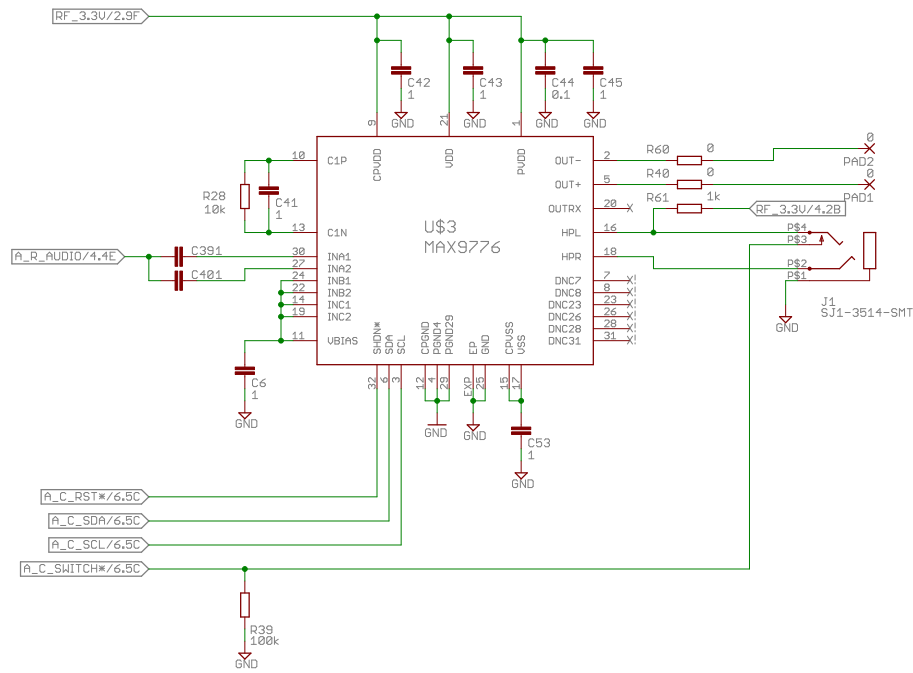

New Audio Subsection

Corona Manufacturing
 1502 Emblem Drive
 Pflugerville, TX 78660

TITLE: digital	
Document Number:	REV: C
Date: 10/28/2009 9:36:09 PM	Sheet: 3/9

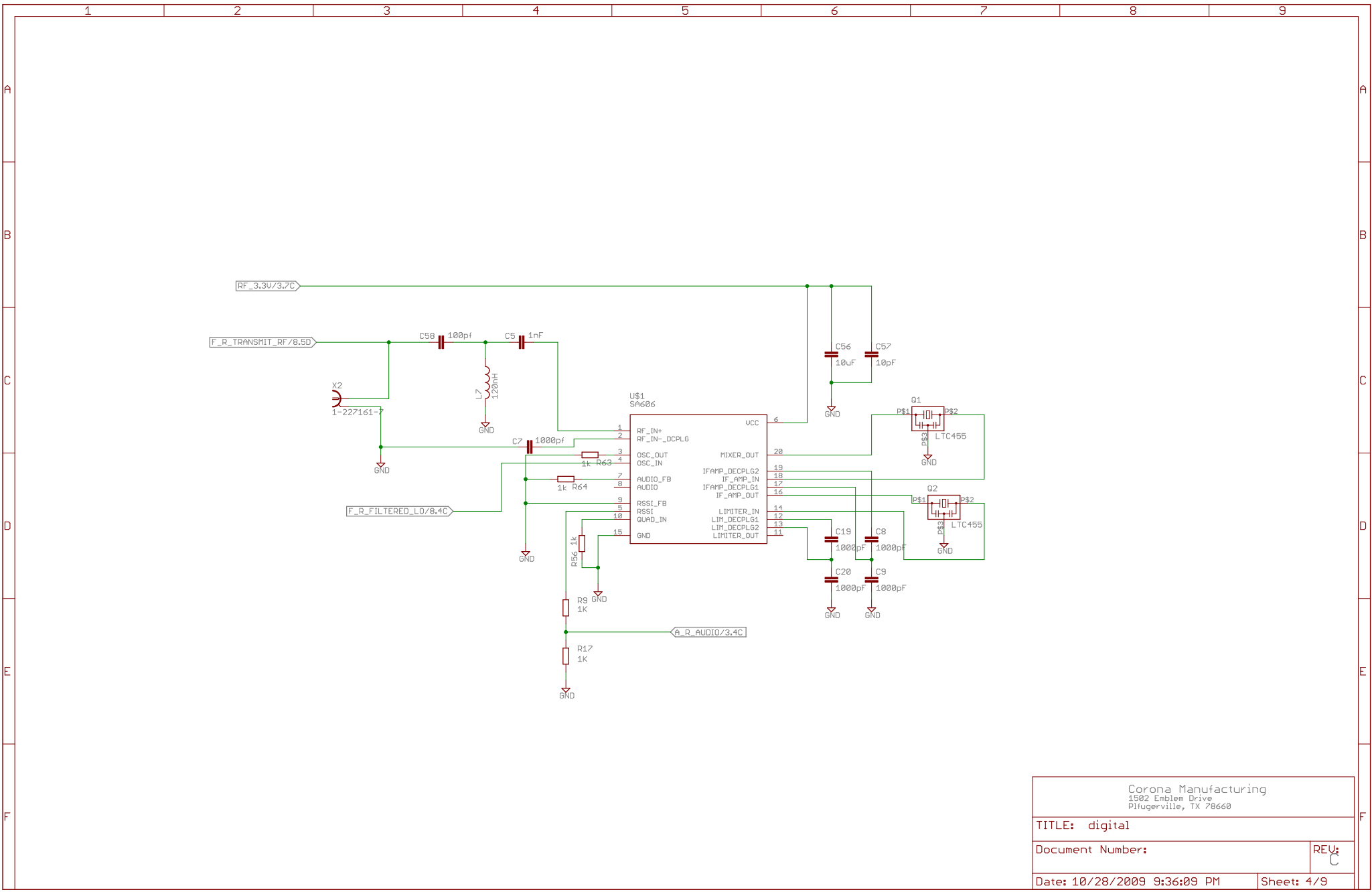

Corona Manufacturing 1502 Emblem Drive Pflugerville, TX 78660	
TITLE: digital	
Document Number:	REV: C
Date: 10/28/2009 9:36:09 PM	Sheet: 4/9

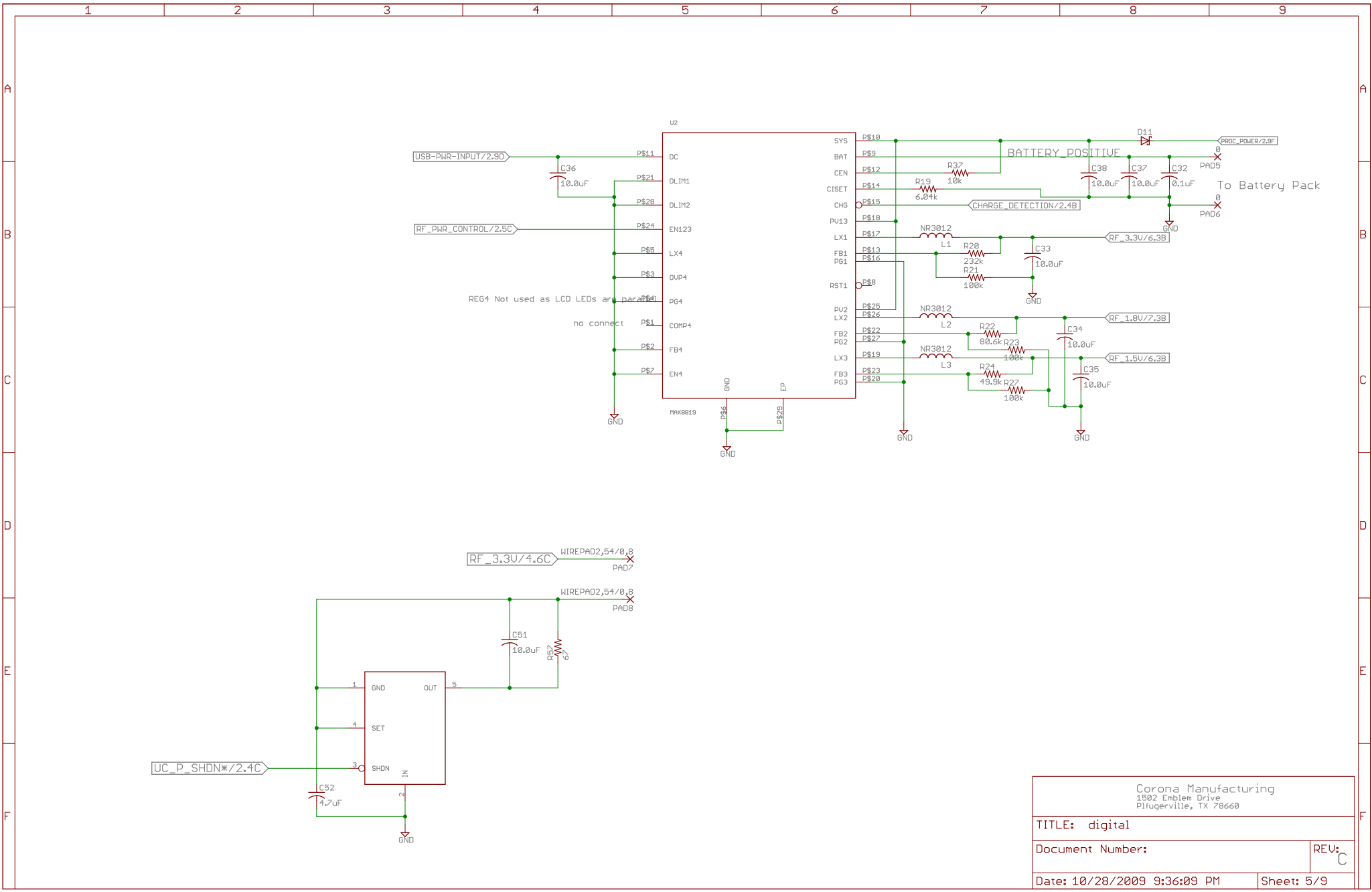

Corona Manufacturing 1502 Emblem Drive Pflugerville, TX 78660	
TITLE: digital	
Document Number:	REV: C
Date: 10/28/2009 9:36:09 PM	Sheet: 5/9

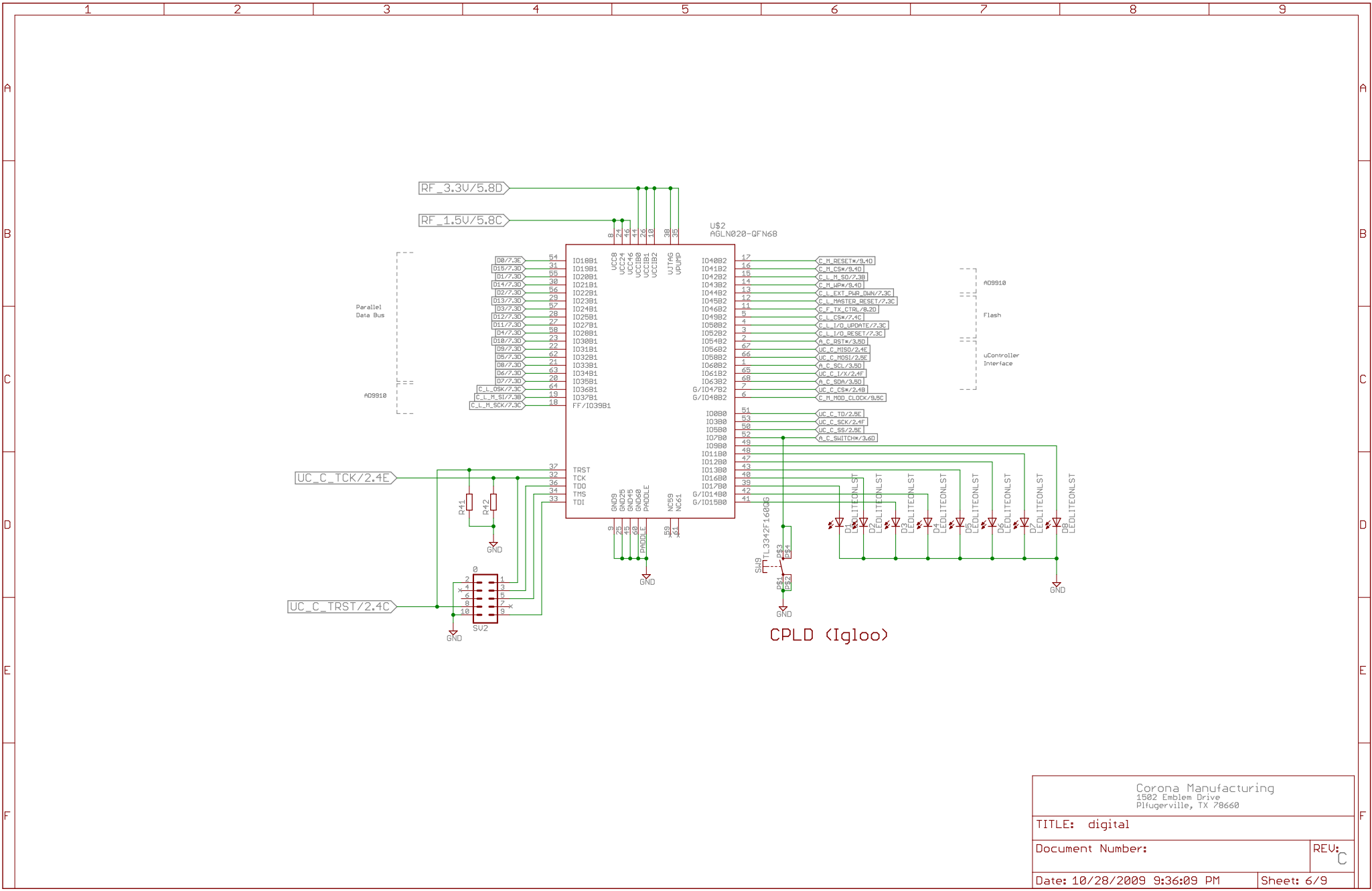

Corona Manufacturing 1502 Emblem Drive Pflugerville, TX 78660	
TITLE: digital	
Document Number:	REV: C
Date: 10/28/2009 9:36:09 PM	Sheet: 6/9

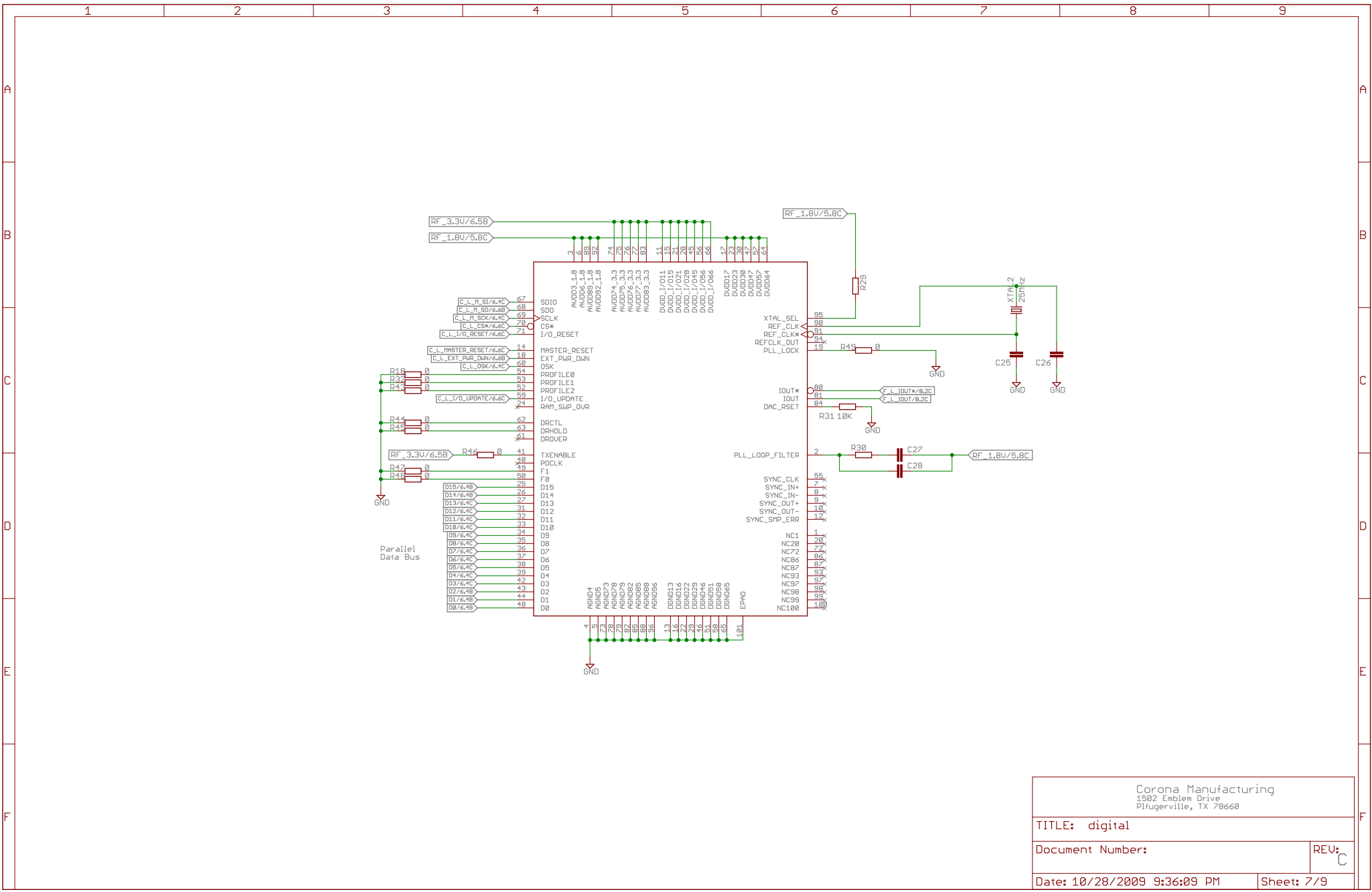

Corona Manufacturing 1502 Emblem Drive Pflugerville, TX 78660	
TITLE: digital	
Document Number:	REV: C
Date: 10/28/2009 9:36:09 PM	Sheet: 7/9

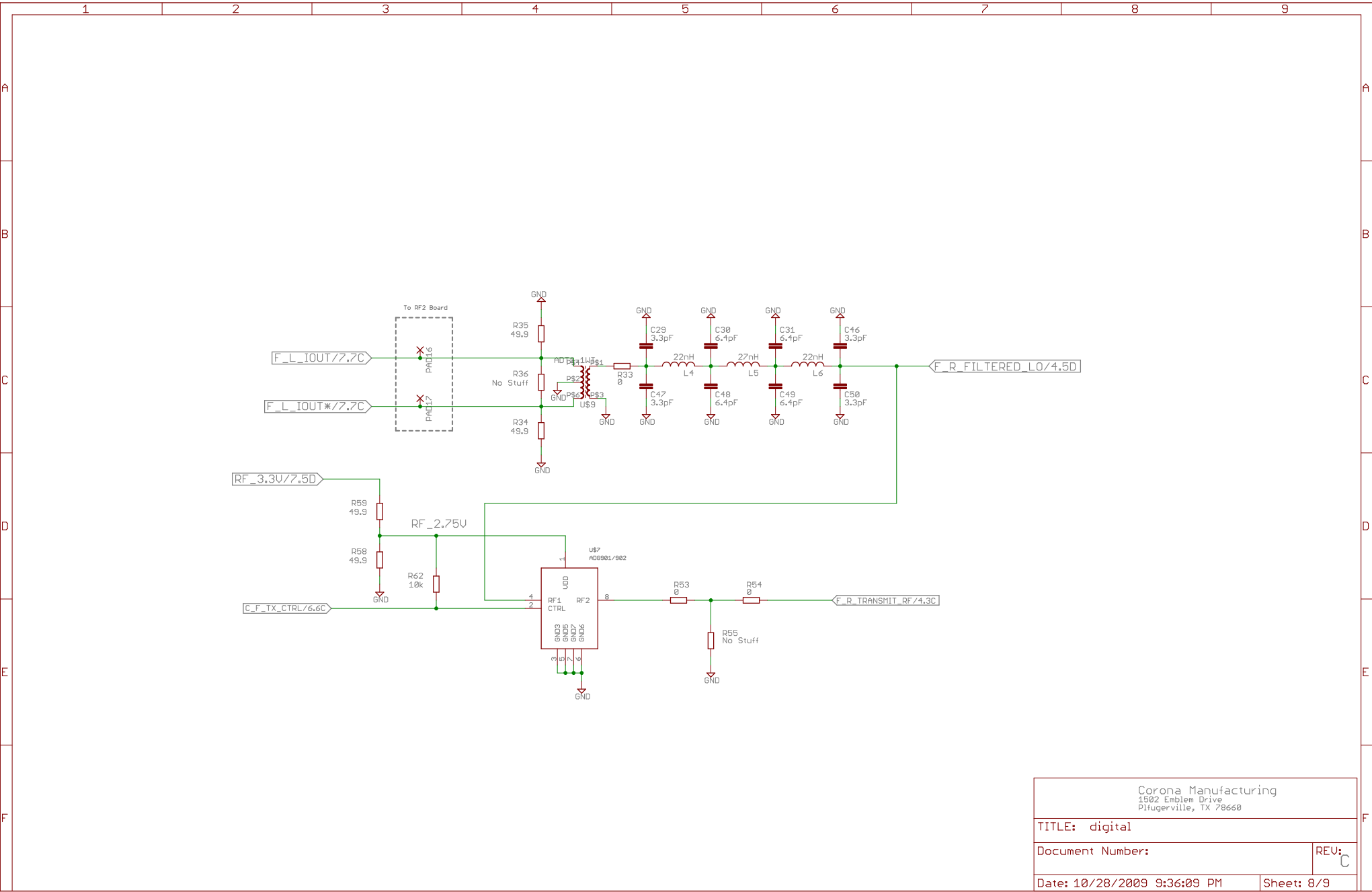

Corona Manufacturing 1502 Emblem Drive Pflugerville, TX 78660	
TITLE: digital	
Document Number:	REV: C
Date: 10/28/2009 9:36:09 PM	Sheet: 8/9

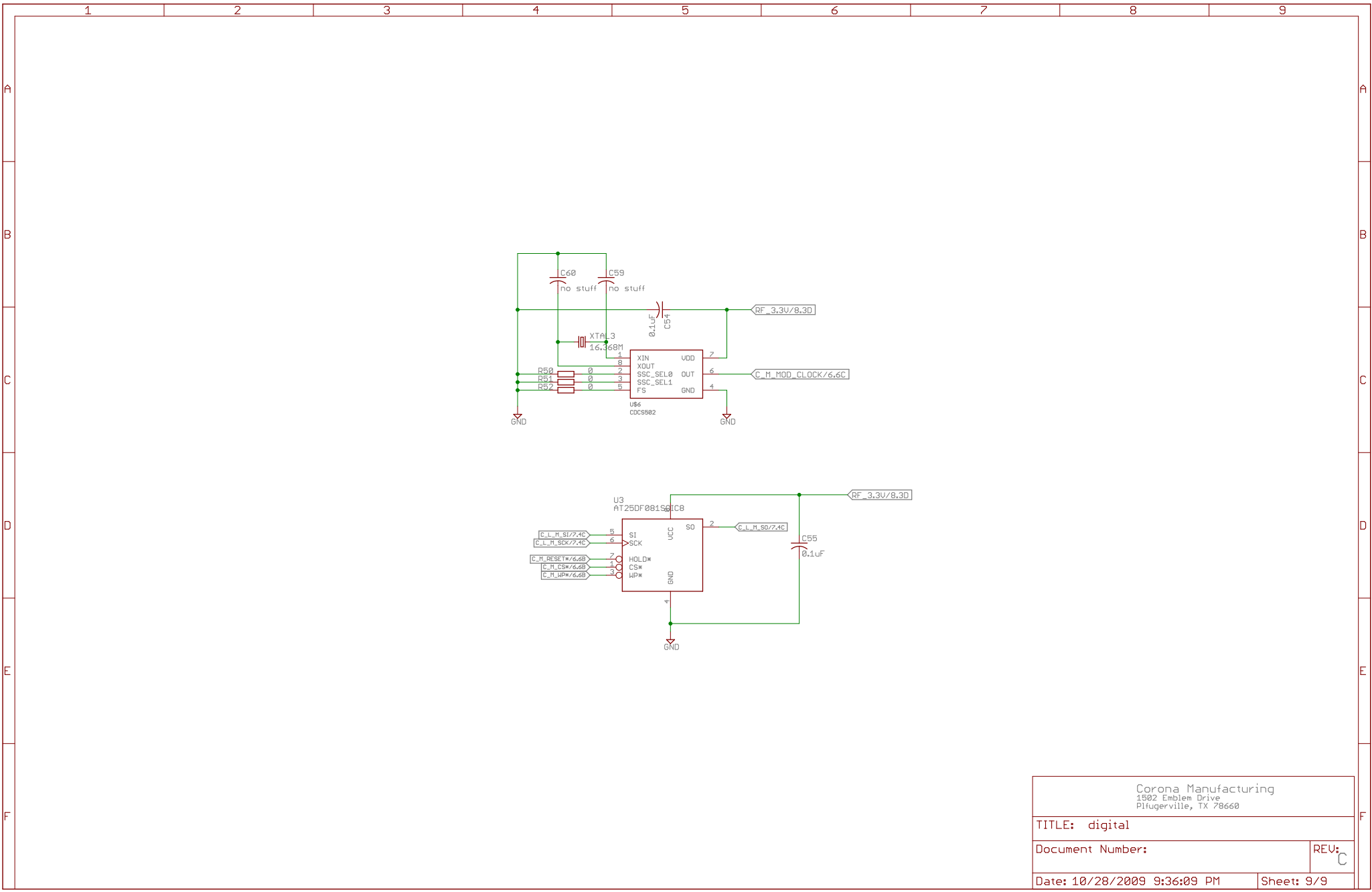

Corona Manufacturing 1502 Emblem Drive Pflugerville, TX 78660	
TITLE: digital	
Document Number:	REV: C
Date: 10/28/2009 9:36:09 PM	Sheet: 9/9